

# FINAL SUBSCRIBER SOCKET NAR-1/PT

# ZAMEL

Zakład Mechaniki i Elektroniki  
ZAMEL sp.j.

J.W. Dzida, K. Łodzińska

ul. Zielona 27, 43-200 Pszczyna, Poland  
Tel. +48 (32) 210 46 65, Fax +48 (32) 210 80 04  
www.zamelcet.com, e-mail: marketing@zamel.pl

## APPEARANCE

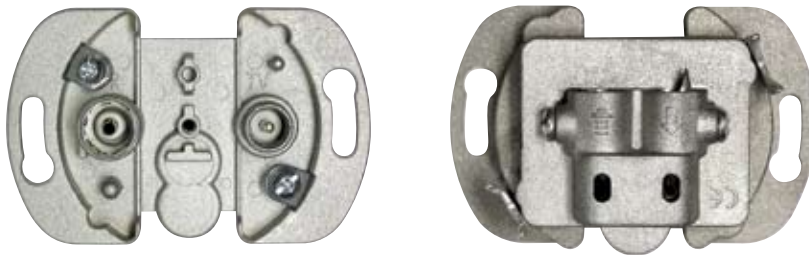

CE A CLASS

## DESCRIPTION

- Designed for analogue and digital RTV installations,
- final socket for aerial systems of a star-shaped type or individual aerial installations,
- one input port for coaxial conductor conducting signal in the frequency of 5÷862 MHz
- two output ports consistent with standard IEC 60169-2 to connect radio receiver "R" and TV receiver "TV",
- usage of the frequency ranges of bands TV, R,
- full characteristic of transmission in particular bands,
- high separation between particular ports,
- transfer of DC voltage on TV output,
- the possibility of power supply through aerial amplifiers socket,
- galvanic separation of input from R outputs,
- reliability and repeated nature of parameters, thanks to the performance in the SMT technology,
- casing of high screening efficiency made of ZnAl alloy,
- socket can be used as R or TV signal digital adder.

## CERTIFICATES

On the basis of the document: TECHNICAL ASSESSMENT No 468/2003 of the Institute of Communications, the socket NAR-1/PT fulfils the basic requirements stipulated in standards:

- PN-EN 50083:2003 Cable networks intended for signal transmissions: TV, radio and interactive services. Part 2: Electromagnetic Compatibility of Appliances. Chapter: 5.4, Table 8, Class A;
- PN-EN 50083:2002 Cable networks intended for signal transmissions: TV, radio and interactive services. Part 4: Passive broadband appliances for coaxial cable networks. Chapter: 5.3,
- PN-EN 60728-11:2005(U) Cable networks intended for signal transmissions: TV, radio and multimedia services. Part 11: Safety requirements. Chapters: 10.2, 10.3.

		5	70 88	108 120	174	230	470	862 MHz
		RETURN B1	FM	LOW S bottom special band S2+S8	B III VHF III K06+K12	HIGH S hyperband top special band S9+S38	UHF K21+K69	
Coupling attenuation	IN→R	-	1,5 dB	-	-	-	-	-
	IN→TV	1 dB	-	1 dB	1 dB	1 dB	1,5 dB	
Not fitting attenuation	R	-	12 dB	-	-	-	-	-
	TV	13 dB	-	14 dB	14 dB	16 dB	11 dB	
	IN	18 dB	15 dB	14 dB	15 dB	15 dB	11 dB	
Screening coefficient		83 dB	83 dB	83 dB	82 dB	82 dB	81 dB	
Cross-talk attenuation R↔TV		≥27,7 dB						
Wave impedance IN, OUT		75 Ω						

CHARACTERISTICS

SCHEME

Coupling attenuation IN→TV

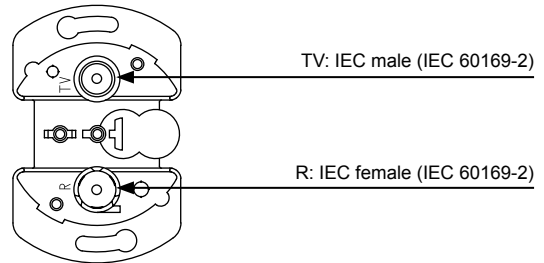
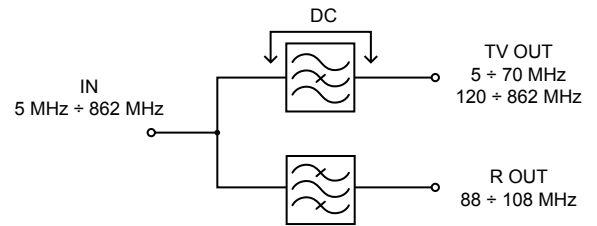
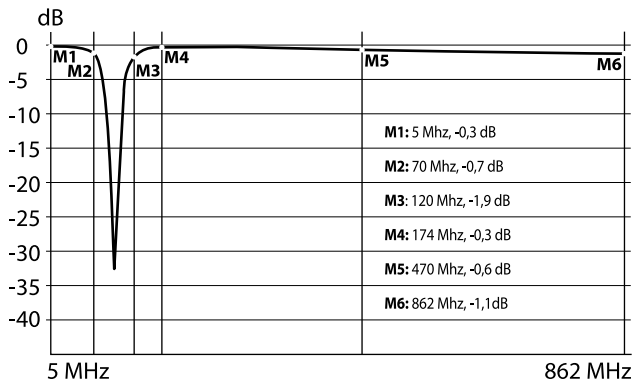

Coupling attenuation IN→R

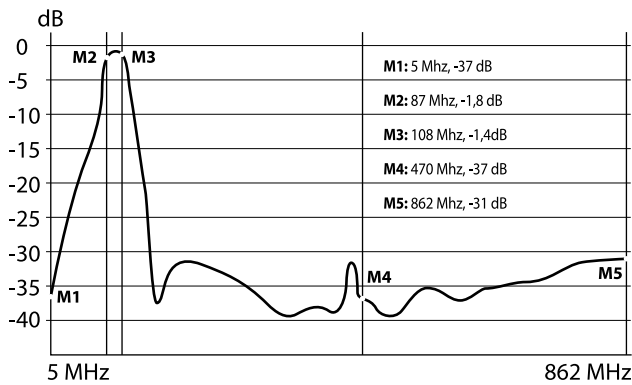

MEASUREMENTS

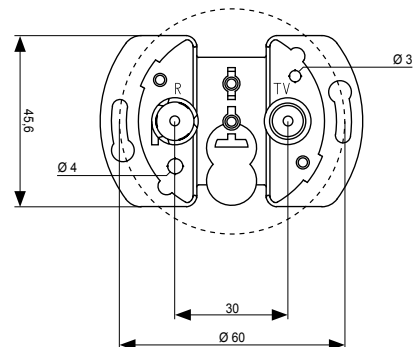

1. Prepare end of aerial conductor for connection, i. e. insulate conductor of concentric cable, cutting off external insulation, plait and cable core at the same length, (illus.1).
2. Unscrew set screw in aerial socket (illus.2).
3. Put aerial conductor into it, so that socket point would go between plait and external insulation. The correctness of putting conductor of cable into input clamp should be checked (illus.4).
4. Screw home set screw in aerial socket (illus.5).
5. Put socket into installation box, size  $\varnothing 60$  mm and depending on kind of socket, fix it with clamps or fixing tap screws.
6. Put on frame with cover on socket body.

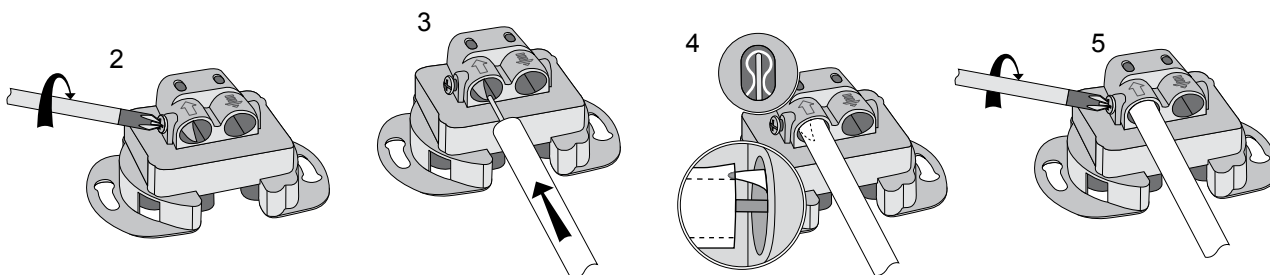
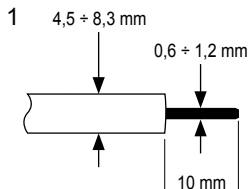

## EXEMPLARY APPLICATION

